

Pages from DomePTZ-3 & DomePTZ-dn3 'Day/Night' User Manual

2. OPERATION

The speed dome camera can be controlled remotely horizontal and vertical movement. It is controlled remotely from the keyboard or controller through a serial connection to the RS-485 connector.

The speed dome camera will conduct a self-check after powered up and the monitor will display as following: "P: P_D, ID: 001, V: 2a1". The information will be disappeared after the self-check is finished. (Protocol and ID code will be displayed according to the users' choice)

Normal Function:

2.1 Pan/Tilt Function

The camera is capable of moving vertically and horizontally. The Pan/Tilt speed is variable for given amount of joystick deflection.

2.2 Lens Function

2.2.1 Zoom Lens Function

Transform the view angle of the camera (zoom in / zoom out), press[TELE] or [WIDE].

2.2.2 Focus Function

In some special circumstance, users need conduct focus manual, he can press [NEAR] or [FAR] to transform the focus and press [CALL] + 59 + [ENTER] or operate the joystick to recover the auto mode.

2.2.3 Iris Function

In normal circumstance, iris is in auto mode. If users need to change the iris level, they can press [OPEN] or [CLOSE] to adjust. Press [CALL] + 60 + [ENTER] or operate the joystick, iris will be auto.

2.3 Preset Function

The speed dome camera is capable of going to 128 preset positions. Each is with its own P/T/Z and focus. (Preset positions 50-66 are reserved for auxiliary functions.) When preset a camera position, the P/T/Z and focus will be memorized for that position.

2.3.1 To set a preset position

[PRESET] + nnn + [ENTER], the LCD displays: SET PRESET : nnn

nnn→the number of preset position: 1~128

2.3.2 To call a preset position

When camera positions have been preset, you can enter a memorized camera position number.

[CALL] + nnn + [ENTER], the LCD displays: CALL PRESET: nnn

nnn→the number of preset position: 1~128

2.3.3 To delete a preset position: (Only be effective to Protocol COP-2. Some special keyboards no function)

[DELPRESET] + nnn + [ENTER], the LCD displays: CLEAR PRESET : nnn

nnn→the number of preset position which will be deleted

2.4 Auxiliary Functions List

Operation	Function
F1 + 0 + Off	Camera reset
F1 + 1 + On	Backlight compensation ON
F1 + 1 + Off	Backlight compensation OFF
F1 + 2 + On	LOW illumination ON
F1 + 2 + Off	Auto LOW illumination
F1 + 3 + On	Menu/Display ON
F1 + 3 + Off	Menu/Display OFF
F1 + 4 + On	Digital zoom ON
F1 + 4 + Off	Digital zoom OFF
F1 + 5 + On	Keyboard LCD display Back Light ON
F1 + 5 + Off	Keyboard LCD display Back Light OFF
F1 + 6 + On	Auto FOCUS
F1 + 6+ Off	Manual FOCUS
F1 + 7 + On	Auto IRIS
F1 + 7+ Off	Manual IRIS
F1 + 8 + On	Auto White balance
F1 + 10 + On	White balance Auto follow model
F1 + 11 + On	Color picture
F1 + 11+ Off	B/W picture

Operation	Function
Call + 33 + Enter	Pan 180°
Call + 51+ Enter	Scan start
Preset + 51+ Enter	Set the start position of scan
Call + 52+ Enter	Scan stop
Preset + 52+ Enter	Set the end position of scan
Call + 53 + Enter	Auto cruise from No.1 preset position to NO.16 preset position
Preset + 53+ Enter	Do self-test
Preset + 54+ Enter	Camera reset
Call + 55+ Enter	Backlight compensation ON
Preset + 55+ Enter	Backlight compensation OFF
Call + 58+ Enter	Digital zoom ON
Preset + 58+ Enter	Digital zoom OFF
Call + 59+ Enter	Auto FOCUS
Preset + 59+ Enter	Manual FOCUS
Call + 60+ Enter	Auto IRIS
Preset + 60+ Enter	Manual IRIS
Call + 61+ Enter	Auto White balance
Preset + 61+ Enter	Auto White balance
Call + 63+ Enter	Image Mirror ON
Preset + 63+ Enter	Image Mirror OFF
Call + 64+ Enter	Show of operation
Preset + 64+ Enter	No show of operation
Call + 67+ Enter	Color video
Preset + 67+ Enter	B/W video
Call + 90+ Enter	Running SEQ after five minutes OFF
Preset + 90+ Enter	Running SEQ after five minutes ON
Call + 95+ Enter	Camera menu ON
Preset + 95+ Enter	Camera menu ON

Operation	Function
Call + n + Enter	To call the number N preset position
Preset + n + Enter	To set the number N preset position
Preset + n + Off	Delete the number N preset position
Cam + n + Enter	Set the dome address “n”
Shot + n + Enter	N=1: Auto the cruise track
Shot + n + Off	N=1: Stop the cruise tracks
Wide	ZOOM wide
Tele	ZOOM tele
Far	FOCUS far
Near	FOCUS near
Open	IRIS open
Close	IRIS close

(1) Title Display Function

No.64 preset position can turn on or turn off the display function (including self-check information display) of some certain cameras. If the No.64 preset position is a normal one, the camera does not have the display function (including self-check information display).

(2) When camera performs cruise function, the tolerant state is as follows:

To scan point by point automatically from No. 1 preset position to No. 16 preset position. The cruise will not scan those positions where certain positions are un-preset or deleted after preset, and resort time for each preset position is 3 seconds;

(3) When camera performs scan function, the tolerant state is as follows:

The camera will scan automatically between two designated positions, namely “starting point” (left) and “end point” (right). The resort time at “starting point” and “end point” is 3 seconds; states of dome camera are shown below. The dome camera will stop scan and implement new action when receiving qualified command.

Note: The dome camera may result in accumulative deviation in parameters after serving a long period. The starting point and end point of scan shall be reset.

(4) The item marked with * means the camera have this function, otherwise it will show “NO FUNCTION”.

5. Special Function—Power-off Protection

When the camera is under scan or cruise track, and power off occurs, the camera will save the state before the power-off. When power is resupplied, the camera will continue to perform the scan or cruise track automatically under the same state before power-off. Should scan or cruise track are not performed before power-off, the camera will stop at the first preset position automatically.

3.ID SETTING

ID of this speed dome can be set by the switch with 10 codes. Below is the detail of setting ID code:

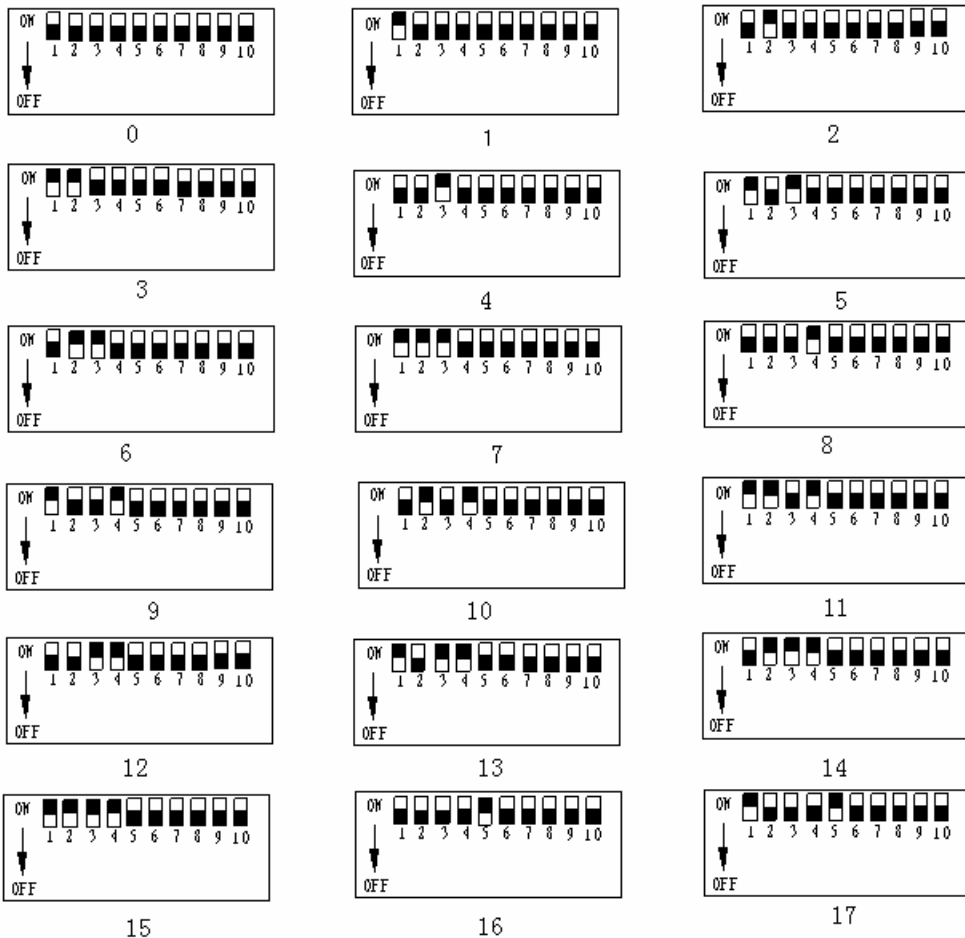

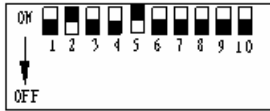

18



19

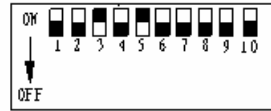

20

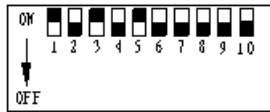

21

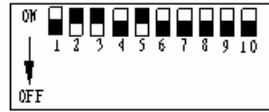

22

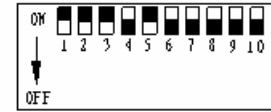

23

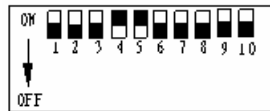

24



25

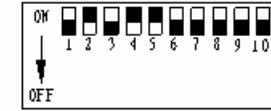

26

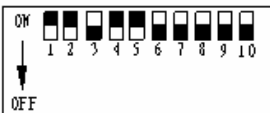

27



28



29

-

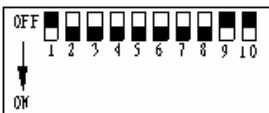

254

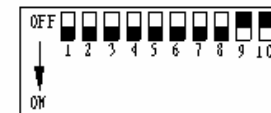

255

Note: Control cables can connect multiple speed dome cameras in parallel provided that No. 10 ID code of the farthest camera is set to “ON”. The operation is required when the control distance is quite far.

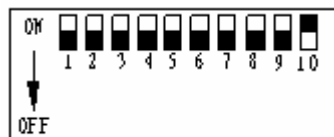

The No. 10 ID code should be set to “ON” for the last camera connected to the daisy chain.

4.PROTOCOL SETTING

Protocol of this speed dome can be set by the switch with 3 protocol codes. Below is the detail of setting protocol code:

Note: All setting must be operated after power off.

Power on until it is completed. !

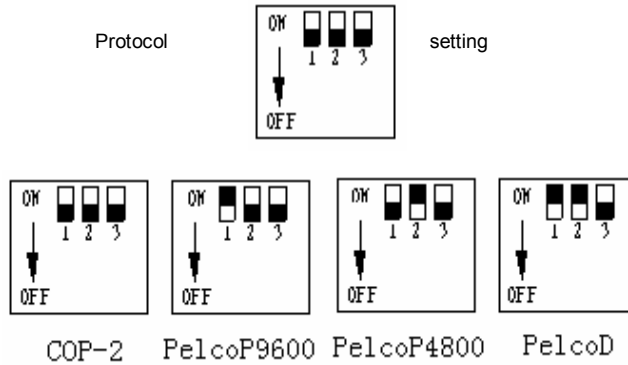

5. CONSTRUCTION

Indoor Speed Dome NOT STOCKED

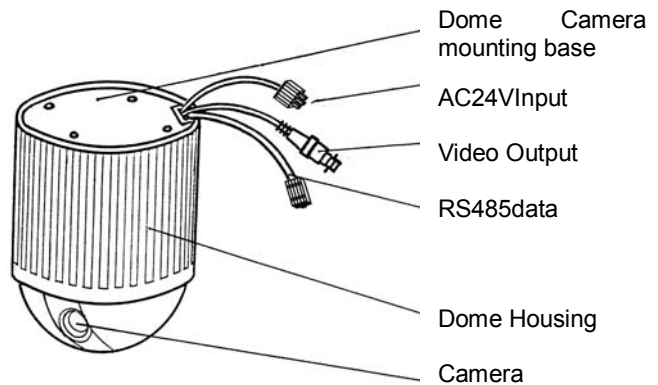
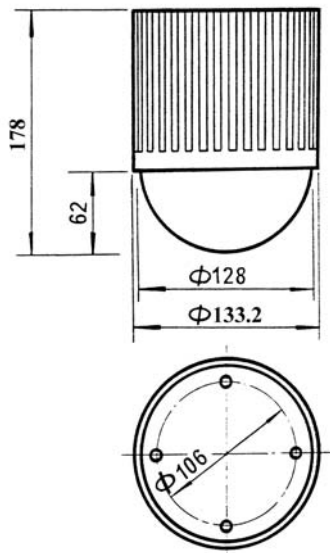

◆ CONNECTIONS

PRECAUTIONS

- ※ The following connections should be made by qualified service personnel or system installers in accordance with all local codes.

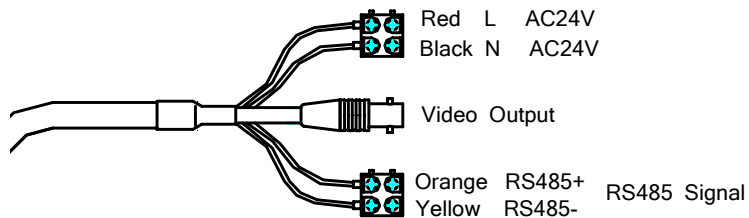

Note: When powered up, the camera performs a self-check for about 2 minutes (including one panning, tilting, zooming and focusing operation). During the period, control operations are not executed.

DomePTZ-dn3 Outdoor Speed Dome Camera

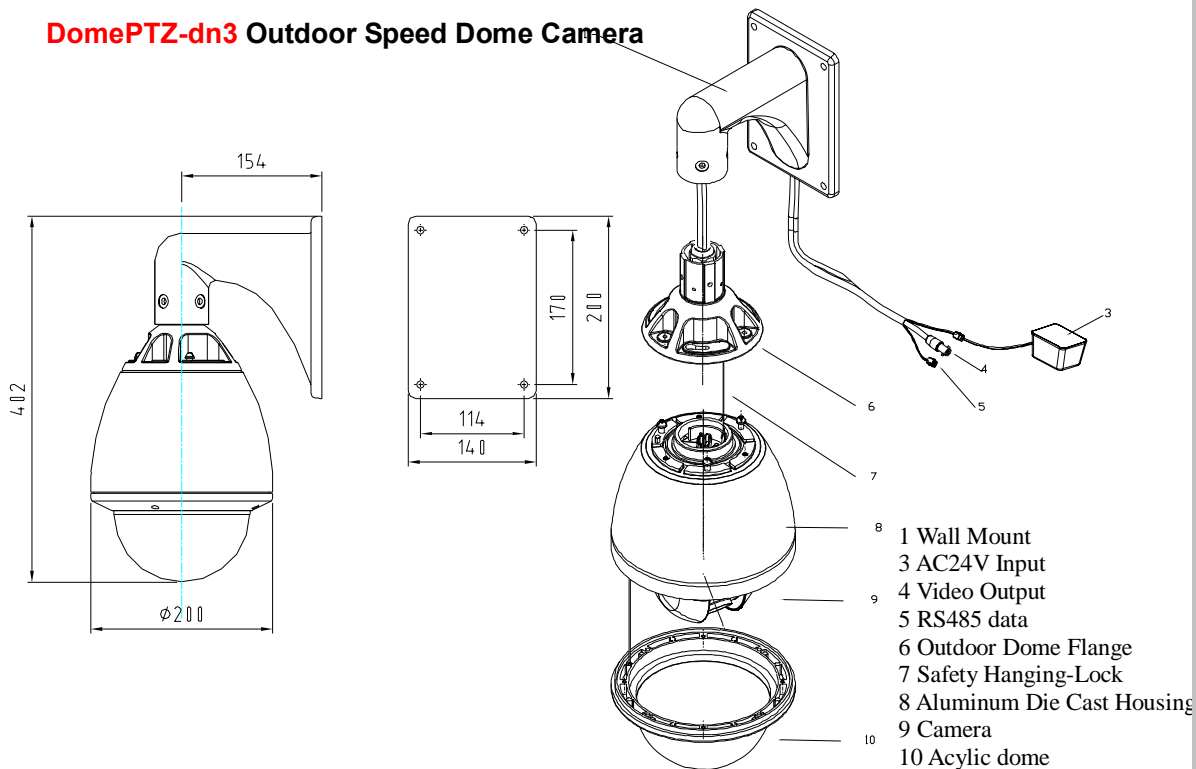

◆ CONNECTIONS

PRECAUTIONS

- ※ The following connections should be made by qualified service personnel or system installers in accordance with all local codes.

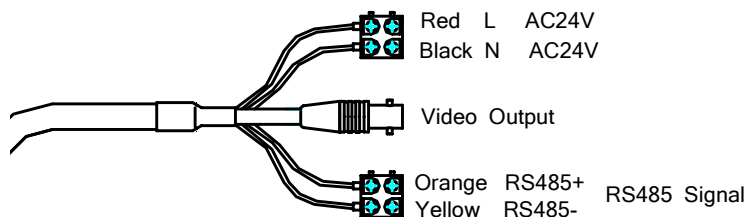

Note: When powered up, the camera performs a self-check for about 2 minutes (including one panning, tilting, zooming and focusing operation). During the period, control operations are not executed.

6. TROUBLESHOOTING

Trouble	Possible Causes	Solution
No action, no video after powered up	Power supply is not well connected	Replace
	Engineering cable failure	Eliminate
	The power supply is not well connected	Correct
Self-check isn't normal, but image is normal and obstacle found in operation.	Machine failure	Repair
	The camera is declining	Put straight
	Voltage is low	Change power and place it near the camera The distance between AC24V power supply to dome camera must be less 50 meters
Self-check is normal but no image	The contact of video cables is incorrect	Correct
	The contact of video cables is loose	Eliminate
	Camera is damaged	Replace
Self-check is normal but it is uncontrollable	The connection of control signal is incorrect	Correct
	Camera number is not set correctly.	Reinstall
	Protocol setting is incorrect	Correct
	RS485 cable A+&B- connection is not correct	Correct
	RS485 cable is too long	The maximum cable for RS485 communication is 1.2km
Instable image	RS485 signal network is star configuration	Star distributor is used at junction of connection
	The contact of video cables is loose	Eliminate
The camera is uncontrollable and running unceasingly	Voltage is low	Replace
	Dropout occurs due to low voltage	Check ID address settings
	Self-check is abnormal	Power up again
	The operation of mainframe is not correct	Power up again
	RS485 bus line isn't equipped with matched resistance, or the resistance is not matched.	Correct
Abnormal video	Extremely bright video	No termination or high resistance

7. CONNECTION OF RS485 BUS AND TERMINATION RESISTOR

(1) Characteristics of RS485 Bus

As specified by RS485 standards. RS485 Bus is of half duplexed data transmission cables with characteristic impedance as 12. The maximum load is 32 unit loads (including main controller and controlled equipment.)

(2) The RS485 standards require a daisy-chain connection between the equipment. There must be termination resistor with 120 ohms impedance at both ends of the connection (refer to the following FIGURE)

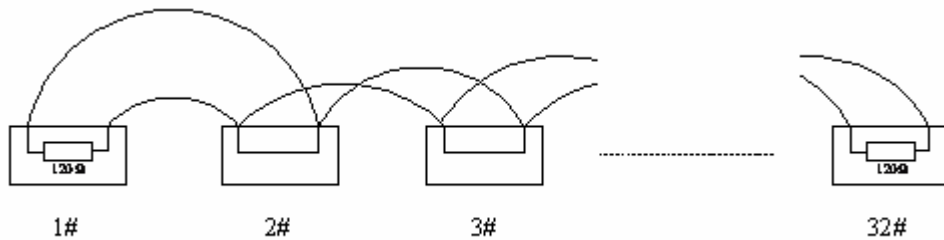

When No. 10 bit of the Dip is set to "ON", the 120 ohms termination resistor is connected.

(3) Problem in Practical Connection

In some circumstances user adopts a star configuration in practical connection. The termination resistors must be connected to the two equipments (No. 6 and No. 10) that are farthest away from each other. But the connection does not meet the RS485 standards.

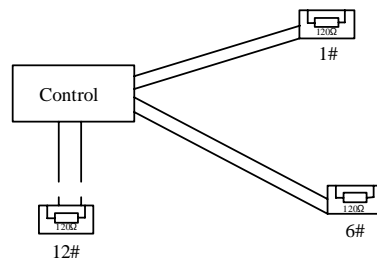

When the cable distance of equipments are far away, some problems, such as signal reflection, anti-jamming ability decrease are easily occur and result in the reliability decline of control signal. The resulted phenomena represent that the camera is out of control completely or interruptedly or operates automatically and fails to stop, etc. In such circumstances the factory recommends the RS485 Signal Distributor. The distributor can change the star configuration connection to the mode of connection stipulated in the RS485 standards. The new connection achieves reliable data transmission.

RS485 Distributor

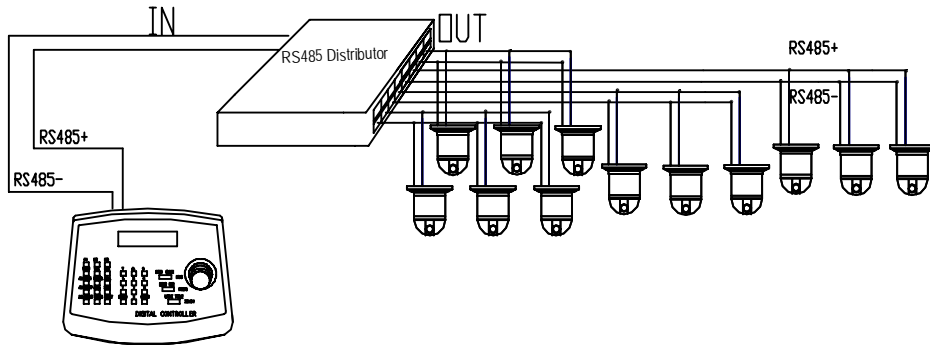

Each connection can connect 32 terminations, and practical connections must be considered.

B. CEILING MOUNT (Option)

- ① Disassemble the Outdoor Flange and dome housing with wrench. Decide the protocol and ID code(fig.1), and mount the dome housing as following.
- ② Fix the ceiling bracket and connect it with outdoor flange with screws and wrench. Tighten the screws as following.
- ③ Connect all the cables as required.
- ④ Mount the Safety Hanging- Lock of the outdoor flange on the outdoor speed dome. Aim the guide pin of mounting base at the longest curved chute of outdoor flange. Fix the speed dome on the outdoor flange. Tighten the screw as following.

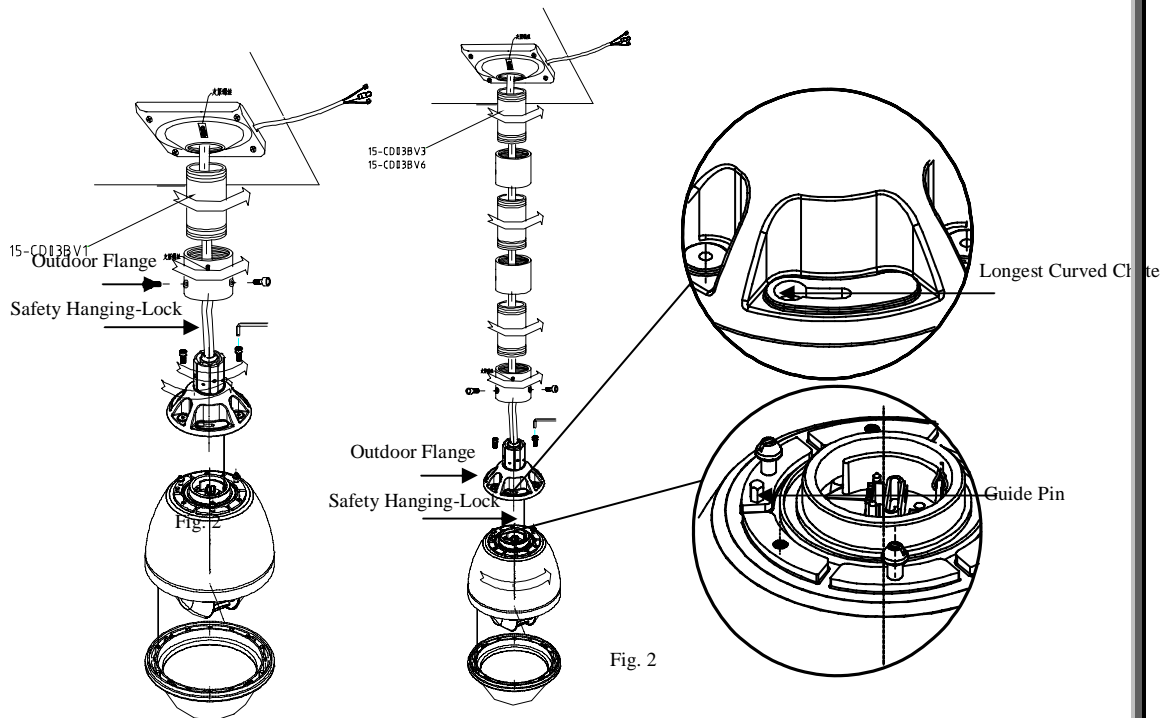

APPENDIX: Camera Module

How to enter the menu of Camera Module

1. To execute the order CALL+95+ENTER into the menu.
2. Then you will see the menu

Main Menu (Page 1.)

S	E	T	U	P	M	E	N	U	(1	/	3)
→	W	H	I	T	E	B	A	L	A	N	C	E	
	I	R	I	S									
	A	G	C	·	S	E	N	S					
	B	A	C	K	L	I	G	H	T				
	E	N	H	A	N	C	E	R					
	Z	O	O	M	·	F	O	C	U	S			
	H	/	V	R	E	V	E	R	S	E			
	T	I	T	L	E								
	P	R	E	S	E	T							

Main Menu (Page 2.)

S	E	T	U	P	M	E	N	U	(2	/	3)
→	M	O	T	I	O	N	D	E	T	E	C	T	
	P	O	S	I	T	I	O	N					
	G	A	M	M	A								
	P	O	W	E	R	O	N						
	M	A	S	K									
	O	S	D										
	Z	O	O	M	+	A	F						
	L	A	N	G	U	A	G	E					
	C	O	M	M	·	I	D						

Main Menu (Page 3.)

S	E	T	U	P	M	E	N	U	(3	/	3)
→	C	R	O	S	S	L	I	N	E				
	F	R	E	E	Z	E							
	P	O	S	I	/	N	E	G	A				

Sub Menu

◆ White Balance

W	H	I	T	E	B	A	L	A	N	C	E						
→	C	O	L	O	R	O	F	F									
						O	N										
						→	A	U	T	O							
							E	X	T								
	W	B				→	A	T	W	R	-	-	-	■	-	-	B
							A	W	B	R	-	-	-	■	-	-	B
	G	A	I	N		→	R	-	Y	-	-	-	-	■	-	-	-
							B	-	Y	-	-	-	-	■	-	-	-

This is used to control the color ON/OFF and white balance and the gain rate of RED & BLUE color.

1. 「COLOR」 selector : OFF is monochrome image , ON is normal color image , AUTO is at low light AGC up, display image will be auto

change to monochrome image.

2. 「WB」 White balance control : ATW is Auto trace white balance, can be adjust offset level. AWB is One push white balance. Push [menu] key 「AWB」 will start flicker, until flicker stop it will lock the current color temperature at the same time.

3. 「GAIN」: The gain rate of R-Y & B-Y can be adjusted separately.

◆ IRIS



This is used to control the iris & shutter speed of the lens. It included 3 items “PEAK”, “ALC”, “AES”.

1. 「PEAK」 is used to control the reaction of auto iris, which is based on the average light of picture signal or the light rate of the peak.

2. 「ALC」 is used to select AUTO or FIX. Adjust IRIS level

This is used to control “BLC” (Back Light Compensation),

1. 「BLC」 ON / OFF selector. Selector 「ON」 has 2 sub-items : 「AREA」, 「SENS」.

2. 「AREA」 : 48 BLC zones can be set separatly. According to the mask area (BLC zone) signal to decide the iris and shutter speed.

3. 「SENS」 : Is used to enhance the BLC effect.

◆ ENHANCER

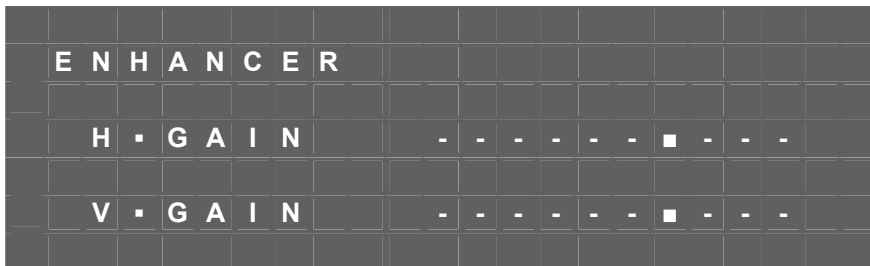

This is used to enhance the compensation of the picture quality.

1. 「H • GAIN」 : Horizontal Compensation

2. 「V • GAIN」 : Vertical Compensation

◆ ZOOM • FOCUS



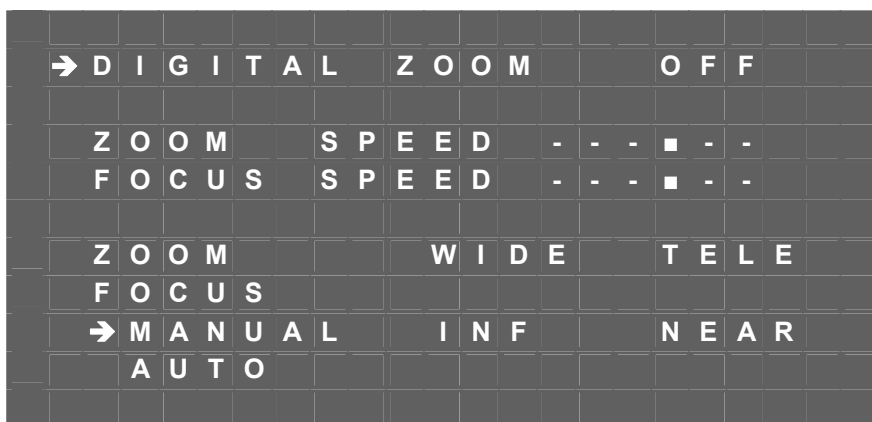

This is used to control the motion of the lens, included “Digital ZOOM” ON/OFF and times set function.

1. 「Digital ZOOM」 selector : OFF、X2、X4、X6、X8、X10.
2. 「ZOOM Speed」: Set the speed of the zoom.
3. 「FOCUS Speed」: Set the speed of focus.
4. 「ZOOM」: Lens ZOOM adjust WIDE / TELE
5. 「FOCUS」: AUTO / MANUAL setting

◆ H/V REVERSE

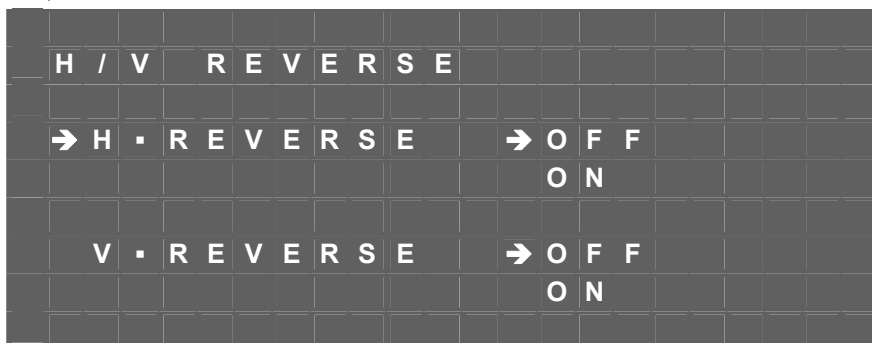

This is used to select image 「Horizontal Reverse」



This is used to select the camera go back to “PRESET”, “INITIAL”, “PHASE” condition

1. 「PRESET」 : Set to ON camera will be reset and set to default data.
2. 「INITIAL」 select : Set to ON lens is action, Set to OFF lens is not action.
3. 「PHASE」 adj select : Set to OFF ext-sync is disable, Set to ON ext-VD sync is enable, (EXT-VD signal must be input)
4. PHASE set to ON sync-phase adjustment.

◆ **MOTION DETECT UNSUPPORTED**

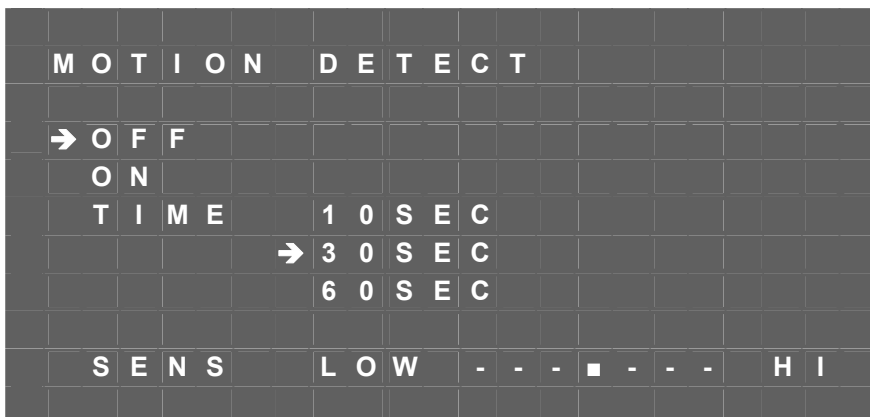

This is used to select the motion detect function.

1. Motion detect ON / OFF select.
2. Motion detects area select.

3. Motion detects output time select.
4. Motion detect sensitive adjust.

◆ POSITION UNSUPPORTED

P	O	S	I	T	I	O	N													
	A	L	A	R	M			N	O	=	0									
	F	R	E	E	Z	E	→	O	F	F										
								O	N											
	P	O	S	I	T	I	O	N												
	→	N	O	=	1															
		Z	O	O	M			S	P	E	E	D	-	-	-	■	-	-		
		F	O	C	U	S		S	P	E	E	D	-	-	-	■	-	-		
		Z	O	O	M			W	I	D	E							T	E	L
		F	O	C	U	S		I	N	F								N	E	A

This is used to set 「ALARM-IN」 function, either 「ALARM POSITION」 or 「IMAGE FREEZE」.

1. 「ALARM NO.」: Set alarm position(1~64), if set to (0) alarm position is not enable.
2. 「Freeze」: Set ON mode, 「ALARM-IN」 is freeze trigger input.
3. 「POSITION」: The alarm position have 64 steps (position) can be programed.

By this program, the zoom & focus may go to the exactly position where is programed.

◆ GAMMA

G	A	M	M	A																
→	T	Y	P	E	1															

T Y P E 2

This is used to select the camera gamma correction.

「GAMMA」select : TYPE-A gamma is 0.45,
TYPE-B gamma is 1.0

◆ POWER ON

	P	O	W	E	R		O	N													
	→	B	L	U	E		B	A	C	K											
					O	F	F														
	→	O	N																		
					P	O	S	I	T	I	O	N									
	→	O	F	F																	
					O	N		N	O	=	1										

This is used to select the camera power on state.

1. 「BLUE BACK」 : Set to OFF camera power on initial is normal display, Set to ON camera power on initial is display blue back.
2. 「POSITION OFF」 : Camera power on lens position is current position.
3. 「POSITION ON」 : Camera power on lens position is go to the designation position(1~64).

◆ MASK

M A S K

This is used to select on screen display ON / OFF select.

1. POSITION NO. display ON / OFF select.
2. MONTION action display ON / OFF select.
3. ZOOM times display ON / OFF select.

◆ ZOOM+AF

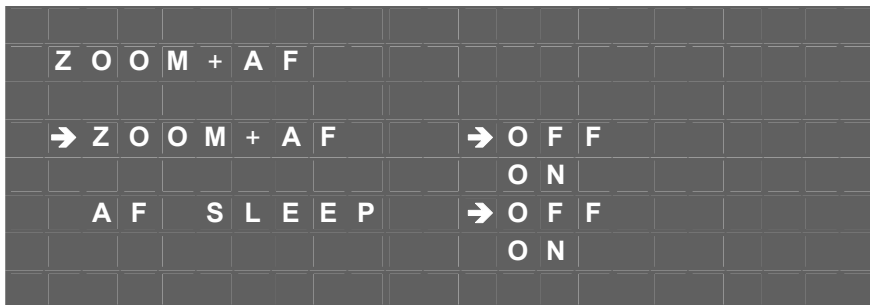

This is used to select an occasion for auto focus action.

1. ZOOM stops time execute lens focus once, action OFF / ON select.
2. AF Sleep function ON / OFF select.

(As show screen stillness about 5 minutes cameras come into AF Sleep mode namely, as screen has bigger change time come back again act for normal mode namely.)

◆ LANGUGE



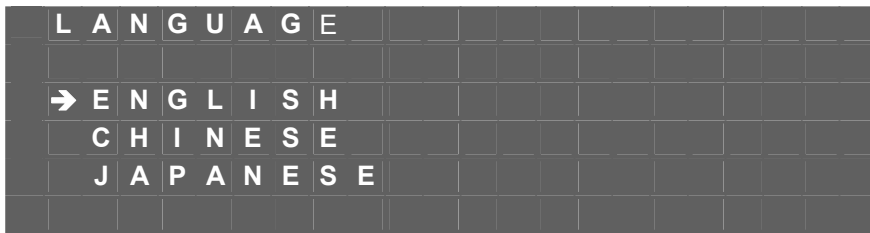

This is used to select OSD manu display language.

OSD display language select, ENGLISH / CHINESE (Simp.) / JAPANESE

◆ COMM·ID

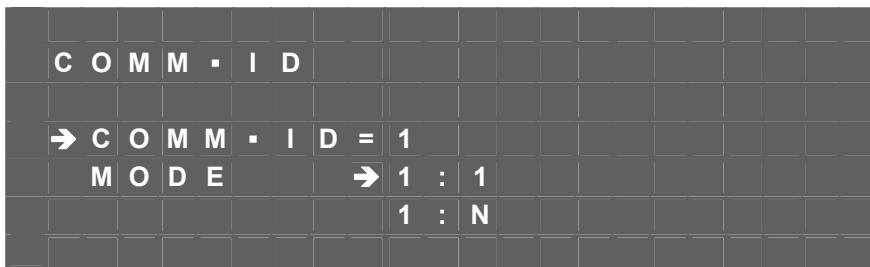

This is used to select communication ID and mode.

1. Communication ID number's set.(Enactment supply controller identification camera uses ID number.)
2. MODE choice
 - 1:1 : One controller to control one Camera.
 - 1:N : One controller to control many Cameras.

◆ CROSS LINE



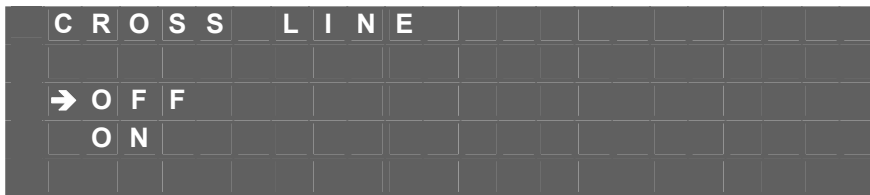

This is used to select the cross line display ON / FF.

Cross line ON/OFF select, set ON cross line display, set OFF cross line is hidden.

◆ FREEZE



This is used to set 「IMAGE FREEZE」.

「Freeze」: Set ON mode, 「ALARM-IN」 is freeze trigger input.

◆ POSI / NEGA

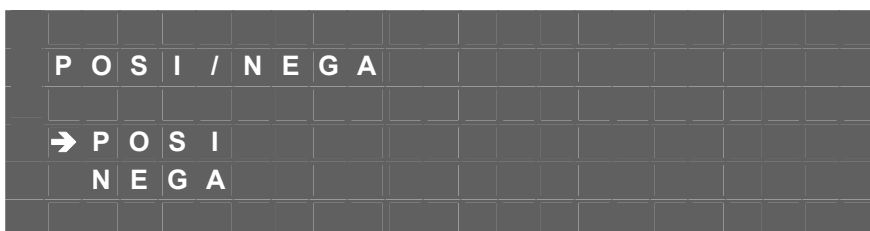

This is used to select image 「Positive」 and 「Negative」 function.

「POSI/NEGA」: Image positive & negative select.